

Proposal and Performance Analysis of Hybrid NDN Based Ad Hoc Routing Combining Proactive and Reactive Mechanisms

Ngo Quang Minh, Ryo Yamamoto, Satoshi Ohzahata, and Toshihiko Kato

Graduate School of Informatics and Engineering

University of Electro-Communications

Tokyo, Japan

mingus@net.is.uec.ac.jp, ryo_yamamoto@is.uec.ac.jp, ohzahata@is.uec.ac.jp, kato@is.uec.ac.jp

Abstract— This paper is an extension of our previous conference paper. In this paper, we propose a new routing protocol for named data networking (NDN) based ad hoc networks. One feature of our protocol is that it adopts a hybrid approach where a proactive routing is used in the producer side network and a reactive routing is used in the consumer side network. Another feature is that we focus only on the name prefix advertisement in the proactive routing. The result of performance evaluation focusing on the communication overhead shows that our proposal has a moderate overhead both for routing control messages and Interest packets compared with some of conventional NDN based ad hoc routing mechanisms proposed so far. The performance evaluation for a network configuration with a moving consumer node also shows the proposal realizes an effective content retrieval.

Keywords— component; Ad Hoc Network; Named Data Networking; Proactive Routing; Reactive Routing; Analytical Performance Evaluation.

I. INTRODUCTION

This paper is an extension of our previous conference paper, which we presented in an IARIA conference [1].

Recently, Information Centric Networks (ICNs) have been widely studied as a future Internet architecture well suited for large scale content distribution. Named Data Networking (NDN) [2][3] has been widely adopted as a platform for ICN research activities. The fundamental adopted in NDN is the name of required content, not the address of hosts containing content. NDN uses two types of packets in all communications: Interest and Data. A consumer requesting a content sends an Interest packet containing the content name. A producer providing the corresponding content data returns a Data packet to the consumer. NDN routers transferring the Data packet cache the packet for future redistribution.

Originally, NDN was designed for wired network topology, but it can be effectively applied to wireless multi-hop ad hoc network topology. Since nodes move around in wireless ad hoc networks, the routing mechanism is a more important research topic compared with wired networks. In NDN, the purpose of routing is how to construct Forwarding Information Base (FIB) for name prefixes, which specifies the correspondence between a name prefix and a face (or a neighbor identifier) to the content with this name prefix.

There are several proposals on the routing in NDN. For the wired NDN topology, those proposed in [4] and [5] are examples introduced in an early stage. Both of them are based on the link state routing protocol, which maintains and advertises link statuses between neighbors, shares the topology information, and creates routing tables from it. The protocol in [6] is a new proposal based on the link state routing considering multipath routing.

In the case of NDN based wireless ad hoc networks, both the proactive and the reactive approaches are proposed [7]-[11]. This trend is the same as IP based ad hoc networks. MobileCCN [8] and TOP-CCN [9] are examples of the proactive routing mechanism. MobileCCN is an application of RIP [12] to the NDN based ad hoc routing. TOP-CCN is an application of OLSR [13]. On the other hand, E-CHANET [10] and REMIF [11] are examples of the reactive routing mechanism, which are considered extensions of Ad Hoc On-Demand Distance Vector routing (AODV) [14].

These NDN based ad hoc routing mechanisms have pros and cons. The proactive routing can create FIB in response to an up-to-date network topology, but has some overheads of routing control message exchange. On the contrary, the reactive routing has no overheads of routing, but has some overheads associated to Interest packet transfer.

From these considerations, we proposed a new NDN based ad hoc routing in our previous paper [1]. Our proposal has the following two features. First, in a typical ad hoc network used in a public space, such as shopping malls and museums, a content producer side has a stable network where producers and intermediate routers are located in fixed positions. On the other hand, consumers are mobile nodes which change their locations quite often. Therefore, a hybrid approach which uses the proactive and reactive routing is considered to be useful. In the IP based ad hoc network, a hybrid routing is also proposed [15]. Based on these considerations, we take a hybrid approach where the proactive routing is adopted in a producer side network, because of its in-advance route setting, and the reactive routing is adopted in a consumer side network, because of its flexibility for mobility.

The second feature is about the procedure of proactive routing. The NDN proactive routing procedures proposed so far are advertising both the network topology and the name prefixes. However, the point of NDN routing is how the name prefixes are disseminated. In order to realize this requirement, it is sufficient that the shortest path information is maintained

for individual producer. So, we propose a new proactive NDN routing focusing on just the name prefix advertisement.

In our previous paper, we evaluated the performance by counting the number of transmitted packets in the static network configuration. The result showed that our proposal is effective compared with the conventional NDN ad hoc routing [1].

This paper is an extension of our previous paper [1]. In this paper, we again state the details of our proposal by adding a flow chart of our algorithm. We also give the performance evaluation using a mobile node network configuration as well as a fixed node network configuration. The rest of this paper consists of the following sections. Section II describes the related work on NDN and NDN based ad hoc routing. Section III proposes our new protocol. Section IV shows the performance evaluation with the fixed node configuration focusing on the routing control and Interest transfer overheads, and Section V shows the performance evaluation with the mobile node configuration. In the end, Section VI concludes this paper.

II. RELATED WORK

This section describes related work on NDN and NDN based ad hoc routing.

A. Overview of named data networking

NDN nodes (consumers, NDN routers and producers) maintain the following three major data structures [2].

- Forwarding Interest Base (FIB): used to forward Interest packets toward producers of matching Data.
- Pending Interest Table (PIT): keeping track of Interest packets forwarded to producers so that returned Data packets can be sent to consumers.
- Content Store (CS): caching received Data packets temporarily.

When an Interest packet arrives on some face, the content name in the Interest is looked up. If there is a copy of the corresponding Data packet in CS, it is sent out to the face the Interest packet arrived on and the Interest packet is discarded. Otherwise, if there is a PIT entry exactly matching to the received content name, the Interest's arrival face is added to the PIT entry and the Interest packet is discarded. Otherwise, if there is a matching FIB entry, then the Interest packet is sent to the face specified in the FIB entry.

As described above, the routing mechanism in NDN is a procedure to create FIB entries for published name prefixes. As for the routing in wired NDN topology, the major protocols proposed so far [4]-[6] are based on Open Shortest Path First (OSPF) [16], which is a link state based intra-domain routing protocol used widely in IP networks. Among them, Named-data Link State Routing protocol (NLSR) [5], for example, introduces two types of link state advertisements (LSAs): Adjacency LSA and Prefix LSA. An Adjacency LSA is similar to an LSA defined in OSPF and contains a list of neighbor name and cost of the link to neighbor. A Prefix LSA is designed for NDN and contains name prefixes. An NDN node sends Periodic "info" Interest packets for neighbor detection. If it receives an "info" Content reply, it considers that a neighbor is alive. An NDN node also sends periodic

"Root Active" Interest packets. If any link state information has changed, its reply is returned. After that, an Interest packet requesting a new LSA and its corresponding Data packet are exchanged.

B. NDN based ad hoc routing mechanisms

For NDN based ad hoc networks, there are a lot of research activities [7]. Among them, MobileCCN [8] and TOP-CCN [9] are typical examples of the proactive routing mechanism. In MobileCCN, NDN nodes regularly broadcast their own FIB, obtain neighbors' FIB, and re-create own FIB. The idea is similar to that of Routing Information Protocol (RIP), in which routers send their own routing table to their neighbors periodically [12]. As is in RIP, the scalability is a problem in MobileCCN.

TOP-CCN is an extension of the Optimized Link State Routing (OSLR) [13] to the NDN based ad hoc routing. TOP-CCN introduces a new packet called Content Announcement (CA). It also introduces the idea of multipoint relay (MPR) and publisher MPT (PMPR). A CA packet contains name prefixes, node id and type of sender, list of neighbors' id and type, and so on. It is used for the neighbor discovery and MPR selection, through single hop broadcast, and for the link state information announcement, through multi-hop flooding. A multi-hop CA packet is generated by PMPR and flooded by MPRs and PMPRs, and it is used to create the topology information and FIB. Since the base of TOP-CCN is OLSR used in IP networks, however, multi-hop CA packets provide over-specified information. For example, a route between consumers, which is never used in NDN, can be obtained from this information.

On the other hand, the reactive routing mechanism is original in ad hoc networks. There are many examples [7], including REMIF [11], which we use in the performance evaluation. REMIF does not use any routing control messages and therefore NDN nodes do not maintain FIBs. Instead, a route to producer is detected during Interest packet flooding. In order to avoid a broadcast storm problem, REMIF adopts differed re-broadcasting with remaining energy checking. Although REMIF has better performance than E-CHANET [10] as for the Interest forwarding overhead [11], the overhead may increase depending on the node density and the average hops between consumers and producers.

III. PROPOSAL

A. Design principles

We have adopted the following design principles for our hybrid NDN based routing mechanism.

- As described above, we divide a whole NDN network into the producer side and the consumer side. In the producer side, NDN nodes including producers and intermediate routers have their location fixed. So, a proactive routing mechanism is introduced in this part. On the other hand, the consumer side includes mobile nodes working as consumers or intermediate routers. Those nodes move around and the network configuration often changes. In this part, a reactive routing mechanism is introduced.

TABLE I. PARAMETERS IN NPAreq AND NPAreP PACKETS.

| packet | parameters |
|--------|---|
| NPAreq | producer node ID, nonce, name prefix list, hop count, number of downstream nodes. |
| NPAreP | producer node ID, nonce. |

- For the producer side, our proactive routing focuses only on the name prefix advertisement. It constructs a directed acyclic graph (DAG) starting from each producer. An FIB entry for a specific name prefix is given by pointing upstream nodes so as to traverse the corresponding DAG in a reverse direction. If there are more than one upstream nodes, all of them are registered in the entry and used for multipath forwarding [16].
- In order to create a DAG for a specific name prefix, the corresponding producer issues a *Name Prefix Announcement Request (NPAreq)* packet. It is broadcasted, and if any receiving NDN nodes are on the corresponding DAG, they return a *Name Prefix Announcement Reply (NPAreP)* packet by unicast.
- As for the consumer side, NDN nodes do not use any control packets for routing. Instead, the FIB entry is created by the first Interest packet for a name prefix. The first Interest packet is flooded throughout the consumer side, and after it reaches some node in the producer side, this Interest packet is transferred to the producer. When the corresponding Data packet returns, a temporary FIB entry is created at the nodes in the consumer side. For the following Interest packets for the same name prefix, this FIB entry is used.

B. Detailed design for producer side

Table I shows the parameters contained in NPAreq and NPAreP packets. *Producer node ID* is the MAC address of the producer node, and NPAreq and NPAreP packets can be uniquely identified using this ID and *nonce*. A producer periodically generates NPAreq packets containing the *name prefix list* which it is publishing. *Hop count* is the number of hops from the producer. When a producer side node receives an NPAreq packet, it rebroadcasts the received packet with incrementing hop count and setting the *number of downstream nodes*, and returns an NPAreP packet to the sender of the NPAreq packet, according to the procedure described below.

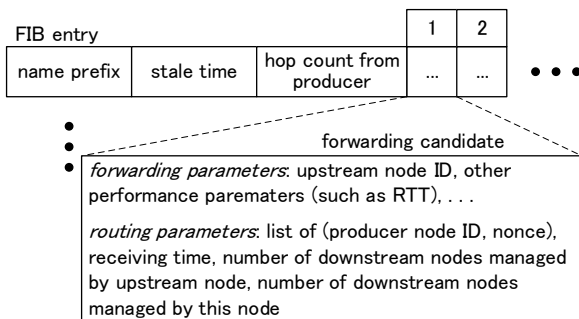

note: forwarding candidates ranked by number of downstream nodes managed by upstream node or by other routing policies

Figure 1. Structure of FIB at producer side.

Figure 1 shows the structure of FIB used by producer side nodes. An FIB entry is created for an individual name prefix, and it may contain multiple forwarding candidates. Each candidate has the forwarding parameters and the routing parameters. The forwarding parameters are the ID (MAC address) of upstream node and other performance related values as defined in [16]. The routing parameters are used both to select and rank the upstream node providing shortest path to the name prefix and to compose a NPAreq packet to be rebroadcasted.

A node receiving an NPAreq packet follows the algorithms depicted in Figure 2.

1. The node checks whether there is an FIB entry for the name prefix specified in the received NPAreq packet.
2. If there are no such entries, it adds a new entry with the MAC address of the sender of the NPAreq packet set in the upstream node ID. It sends an NPAreP packet to the NPAreq sender, and rebroadcasts the NPAreq packet.
3. Otherwise, it checks whether there is a forwarding candidate which has the same producer node ID. If there is such a candidate, then look for candidates in which the nonce is the same as that in the NPAreq packet.
 - (3-1) If there are no such candidates, handle this NPAreq as a new advertisement. That is, it deletes the producer node ID and nonce pair from the list in all of found candidates. If the list becomes empty, it deletes the candidate and adds the producer node ID and nonce with creating a new candidate when necessary. It sends an NPAreP packet to the NPAreq sender, and rebroadcasts the NPAreq packet.
 - (3-2) Otherwise, that is, when there are some candidates having the same pair of producer node ID and nonce with the NPAreq packet, it compares the hop count in the entry with that in the NPAreq.
 - (3-2-1) If the hop count in the entry is smaller, then it ignores the received NPAreq packet.

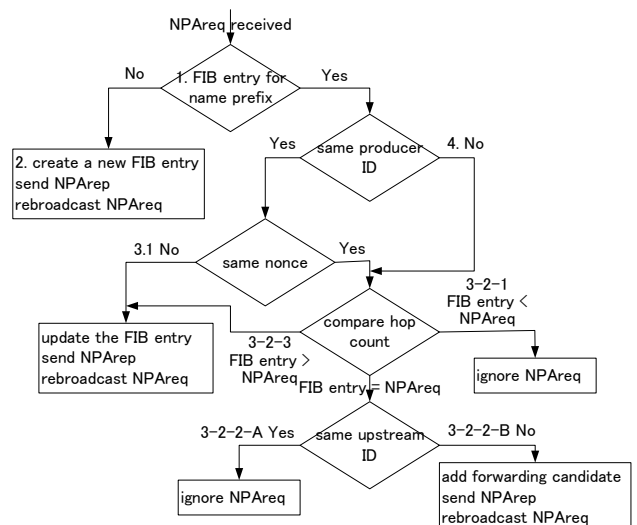

Figure 2. Flow chart for a received NPAreq packet.

(3-2-2) If two hop counts are the same, then it checks whether there are any candidates which have the upstream node ID identical to the NPAREq sender address.

- A) If there is such a candidate, it ignores the received NPAREq packet.
- B) Otherwise, that is, when the NPAREq is sent by a new upstream node, it adds a new forwarding candidate, and returns an NPAREp and rebroadcasts the NPAREq.

(3-2-3) Otherwise, that is, when the hop count in the entry is larger than that in NPAREq packet, it handles this NPAREq as a new advertisement, and acts as specified in step (3-1).

4. Following the first part of step 3, the last step is for when there are no candidates with the producer node ID specified in the NPAREq packet, that is, when an NPAREq with the same name prefix from a new provider. In this case, it compares the hop count in the FIB entry with that in the received packet, and acts in the same way as (3-2-1) through (3-2-3) according to the result.

When a forwarding candidate is created or modified, the number of downstream nodes managed by upstream node needs to be modified according to the received NPAREq packet.

When a node receives an NPAREp packet, it looks for a forwarding candidate with the producer node ID and nonce in the packet, and increments the number of downstream nodes managed by this node by one.

Figure 3 shows an example of this protocol. As shown in Figure 3(a), there are six producer side nodes connected with wireless links shown in dashed lines. Among them, node 2 is a producer and the others are NDN routers. As shown in Figure 3(b), in the beginning, node 2 broadcasts an NPAREq packet with producer node ID = 2, nonce1, “name”, hop count = 1, and number of downstream nodes = 0. Nodes 1, 2, and 5 receive this packet, create an FIB entry as shown in the figure, and return an NPAREp packet individually. Then node 5 rebroadcasts the NPAREq packet with changing hop count to 2, and nodes 4 and 6 respond. Node 2 receives the packet but ignores it. When node 5 receives the NPAREp packets from nodes 4 and 6, the number of downstream nodes in this node is set to 2.

Next, node 1 rebroadcasts the NPAREq packet, to which node 4 responds. As a result, the FIB entry in node 4 has two forwarding candidates to node 1 and 5. Similarly, the NPAREq packet rebroadcasted by node 3 is handled by node 6. In the end of this advertisement, the NPAREq packets are rebroadcasted by nodes 4 and 6, but nobody responds to them. The generated DAG is shown in Figure 3(c).

After some periods, node 2 broadcasts a new NPAREq packet with nonce2. After this new NPAREq packet is disseminated, the FIBs of individual nodes are set as shown in the figure. It should be noted that the FIBs in nodes 4 and 6 have two forwarding candidates with node 5 and nodes 1/3 as the upstream nodes, respectively. These candidates are ranked by the number of downstream nodes managed by upstream node (“dw2”). Since node 5 has two downstream nodes, the forwarding candidate to node 5 is ranked first.

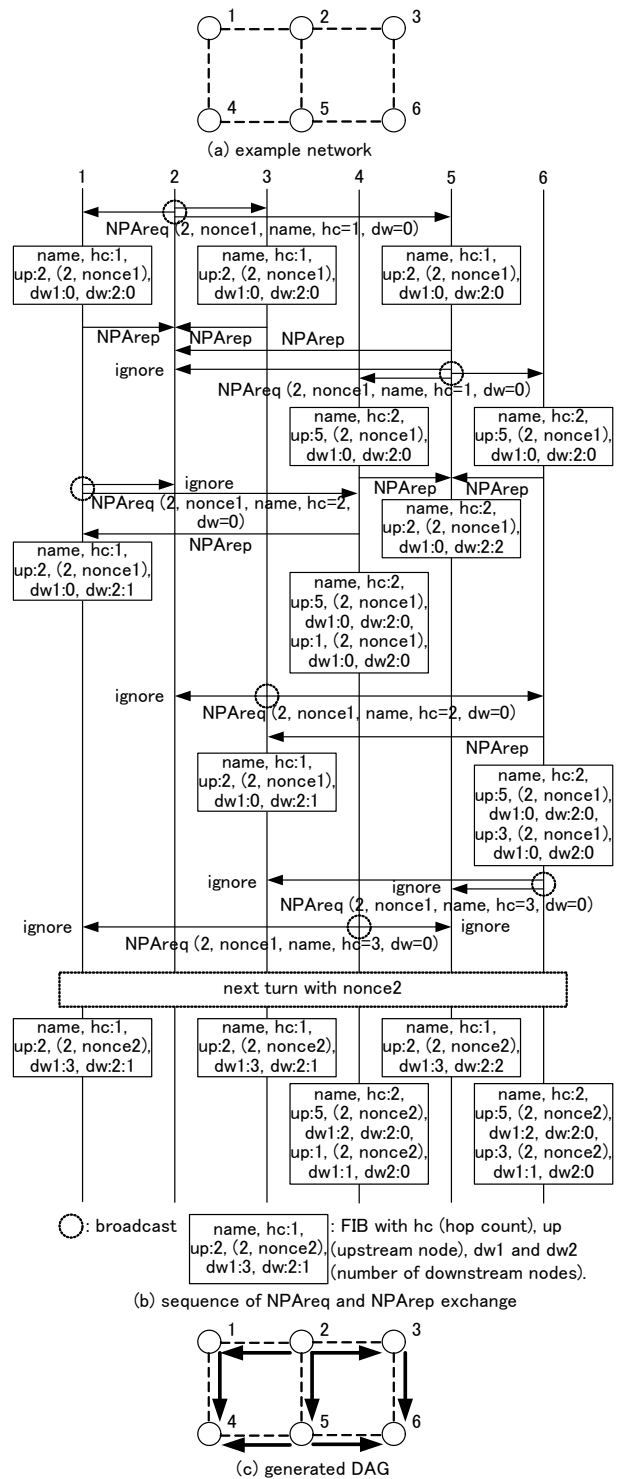

Figure 3. Communication sequence at producer side.

So far in this subsection, we do not mention PIT in producer side nodes. The PIT structure in producer side nodes is identical to that used in original NDN nodes [15], except

that the face ID is replaced by the neighbor node ID (MAC address).

C. Detailed design for consumer side

We introduce a reactive routing mechanism to the consumer side network in the following way. FIB is not set in the consumer side in the beginning. When a node starts to retrieve a specific content, the first Interest packet for the content is flooded among consumer side nodes. When an Interest packet reaches some producer side node, it will be transferred to the corresponding producer. The producer sends back the Data packet containing the requested content. It is transferred through the reverse path of the Interest packet. When it goes through the consumer side nodes, FIB entry is set in individual nodes. The following Interest packets accessing to this name prefix use the FIB arranged. For the consumer side, we use the original formats of Interest and Data packets and the original structures of FIB and PIT, except that the first Interest packet is broadcasted and that a neighbor node MAC address is used as a face ID.

Figure 4 shows an example of the communication sequence between a mobile consumer and a producer. As shown in Figure 4(a), the producer side nodes are the same as in Figure 3(a), and there are three consumer side nodes (nodes p, q, r). The dashed line shows a wireless link.

We assume that the FIBs are arranged in the producer side nodes. As shown in Figure 3(b), node p starts content retrieval for name prefix “name” and the first Interest is for “name/001”. The Interest packet is broadcasted and nodes q and r receive it. Then node q rebroadcasts the Interest packet, and nodes 6

and p receive it. Node p ignores this Interest, because it is a duplicate one. Node 6 relays the received Interest packet to node 5 according to its FIB. On the other hand, node r also rebroadcasts the Interest packet, which nodes 6 and p receive. But both nodes ignore this Interest because of the duplication.

The Interest packet is sent to node 2, the producer, via node 5, and in response to it, the Data packet containing the content of “name/001” is returned along the reverse path of the Interest packet. That is, the Data packet goes via nodes 5, 6, and q , and reaches node p . When node q relays the Data packet, it creates an FIB entry for “name” which indicates that the upstream node is node 6. Similarly, when node p , the consumer, receives this Data packet, it creates an FIB entry for “name” indicating that the upstream node is node q . For the following Interest packets, nodes p and q use the created FIB. That is, the next Interest packet requesting content for “name/002” is sent to node q in the unicast communication. Similarly, node q relays this Interest to node 6 directly.

When some nodes move and the communication link is broken, the Data packet is not returned and the timer for Interest packet will expire. At that time, node p will broadcast the lost Interest packet, and the similar procedure with the first Interest is performed.

IV. PERFORMANCE EVALUATION WITH FIXED NODE CONFIGURATION

This section describes the results of performance evaluation using a configuration where the node position is fixed. The evaluation focuses on the overhead of routing control and Interest packet transfer. We compare our proposal, TOP-CCN as an example of proactive mechanism, and REMIF as an example of reactive mechanism.

A. Experiment configuration

Figure 5 shows the network configuration used in this evaluation. Nodes are arranged in a grid network, n nodes in the horizontal direction and 4 nodes in the vertical direction. Similarly with the examples above, the dashed line is a wireless link.

Figure 5(a) shows the detailed configuration for our proposal. The first and second rows are the producer side, and the third and fourth rows are the consumer side. Figure 5(b) shows the detailed configuration for TOP-CCN. According to [8], the light gray nodes are PMPs and the dark gray nodes are MPRs. In REMIF, all nodes are handled equally.

We assume that some nodes in the first row work as producers. That is, the number of producers change from 1 to n . We also assume that consumers are located in the third and fourth rows. In the evaluation, one consumer communicates with one producer for independent content. So, the cache is not effective in this evaluation.

B. Results of routing control overhead

Since our proposal and TOP-CCN use a proactive routing mechanism, they have some overheads in routing control. Routing control is performed periodically, but in this evaluation, we calculate the total number of control packets exchanged in one turn. We suppose there are m producers.

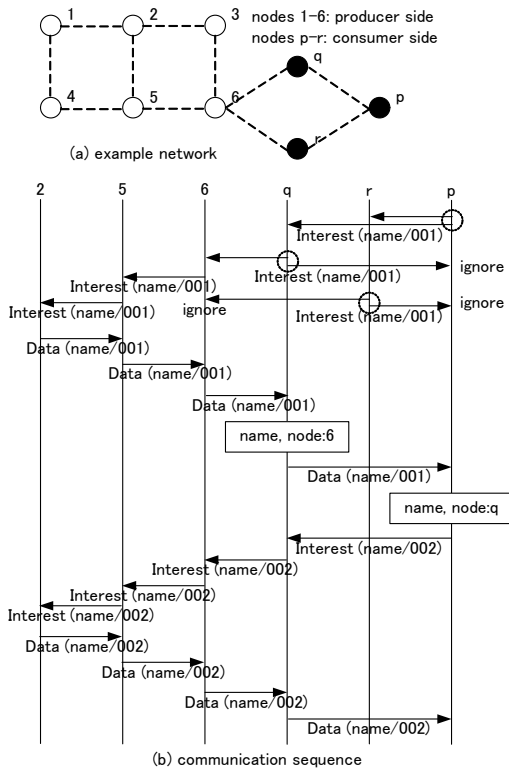

Figure 4. Communication sequence between consumer and producer.

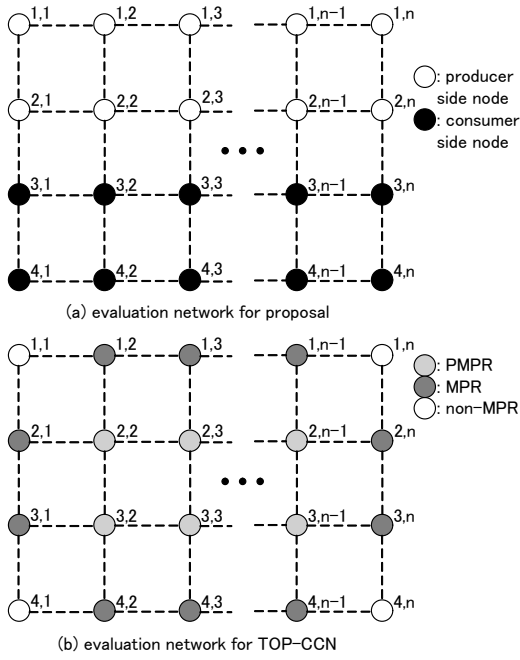

Figure 5. Evaluation network for proposal and TOP-CCN.

(1) Our proposal

The details for our proposal are as follows. First, we consider the case that there is one producer (a node among 1,1 through 1, n). The producer issues an NPAREq packet, and it is rebroadcasted by any other nodes in the first and second rows, once per node. So, the total number of broadcasted NPAREq packets is $2n$. As a result of routing control, a rudder style network is generated as a DAG (see Figure 3(c)). In order to generate this configuration, one NPAREp packet is transferred once over one wireless link. Therefore, the total number of transmitted NPAREp packets is equal to the number of wireless links, that is, $3n - 2$. So, the routing overhead for one producer is $5n - 2$ in our proposal. For the case of m producers, the total number becomes m times as the case of one producer. Therefore, the result is $m(5n - 2)$.

(2) TOP-CCN

In the case of TOP-CCN, the number of control packets does not depend on the number of producers. The details for TOP-CCN are as follows. For non-MPR nodes (white nodes in Figure 5(b)), one CA packet is sent for advertising itself, and another CA packet is sent for MPR selection. So, the number of CA packets is 2 per node. For MPR nodes, a CA packet is sent for one neighbor detection, and the number of neighbors is 3. One CA packet is sent for MPR selection. For route announcement, it sends CA packets as many as the number of PMPR. Therefore, the number of CA packets is $4 + \text{number of PMPR}$ per node. For PMPR nodes, one CA packet is sent after one neighbor detection (there are four neighbors), and one for MPR selection. For relaying multi-hop CA packets, the number of CA packet transfer is equal to the number of PMPR nodes. Therefore, the total number is $5 + \text{number of PMPR}$ per node. The number of MPR and PMPR

is $2n$ and $2(n - 2)$, respectively. As a result, the total number is

$$2 \times 4 + 2n(4 + 2(n - 2)) + 2(n - 2)(5 + 2(n - 2)) = 8n^2 - 6n + 4.$$

(3) Results

Figure 6 shows the number of routing control packets when n is 10 and 20, by changing the number of producers (m) from 1 to 10. When n is 10, the results are summarized in the following way (see Figure 6(a)). In our proposal, the number of NPAREq and NPAREp packets changes from 48 to 480 when m changes from 1 to 10. On the other hand, in TOP-CCN, the number of CA packets is always 744 independently of m . In REMIF, there are no routing control packets.

When the number of nodes in the horizontal axis becomes twice, as shown in Figure 6(b), the situation changes as follows. The number of CA packets in TOP-CCN increases from 744 to 3,084. On the other hand, the number of control packets in our proposal changes from 98 to 980 in response to the increase of m . The number of CA packets in TOP-CCN has a larger increase compared with that of our case. This is because the CA packet number depends on the order of n^2 . In this sense, our proposal is effective in terms of the routing control overhead for the node number increase.

C. Results of Interest transfer overhead

In spite of the weakness in routing control overheads, the proactive mechanism provides more efficient Interest packet transfer than the reactive mechanism. Here, we suppose that there are one hundred Interest packets for one specific name

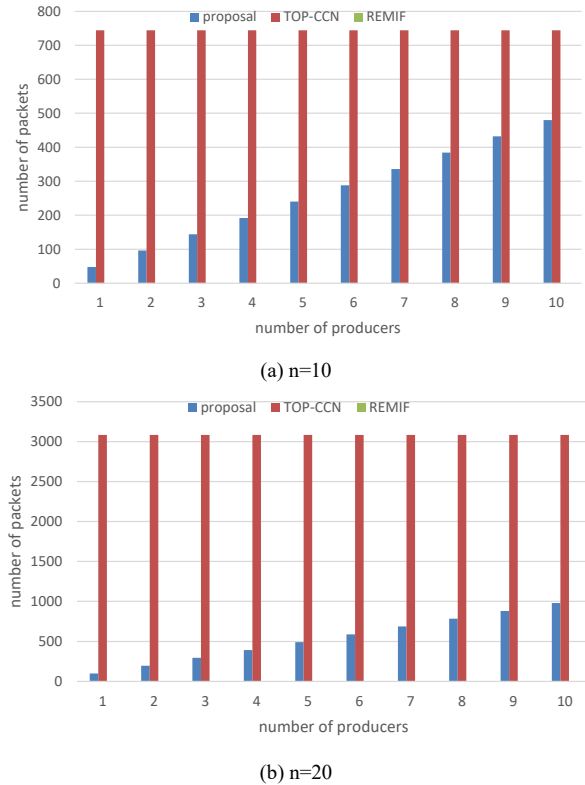

Figure 6. Number of routing control packets.

prefix, and count the total number of Interest packets transmitted over wireless links (*total Interest hop count*). The calculation is done by changing the number of consumer and producer pairs from 1 to n .

(1) *TOP-CCN*

In the case of TOP-CCN, the optimum route is used for all Interest packets. When there is one consumer / producer pair, the average hop count of one Interest packet is obtained in the following formula. Please remember that a producer is located in the first row, and a consumer is located in the third or fourth row. The first item is an average vertical hop and the second is for horizontal transfer.

$$\frac{5}{2} + \frac{\sum_{j=1}^n \sum_{i=1}^n |i-j|}{n^2} = \frac{5}{2} + \frac{n^2-1}{3n}$$

For 100 Interests with m consumer / producer pairs, the total Interest hop count (average) for TOP-CCN is

$$100m \left(\frac{5}{2} + \frac{n^2-1}{3n} \right).$$

(2) *Our proposal*

In the case of our proposal, only the first Interest packet is flooded among consumer side nodes and producer side nodes except the producer itself. So, the total Interest hop count (average) for our proposal is

$$(4n - 1)m + 99m \left(\frac{5}{2} + \frac{n^2-1}{3n} \right).$$

(3) *REMIF*

In the case of REMIF, since there is no FIB, every Interest packet is flooded. In the grid configuration used here, every

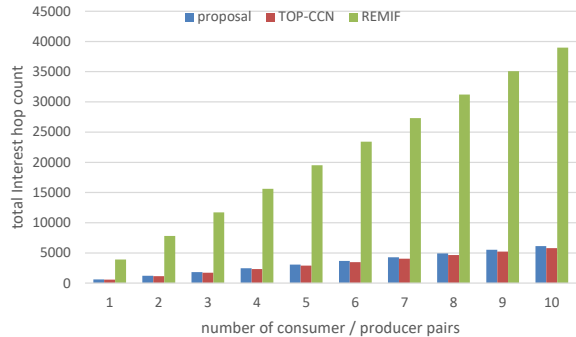

(a) $n=10$

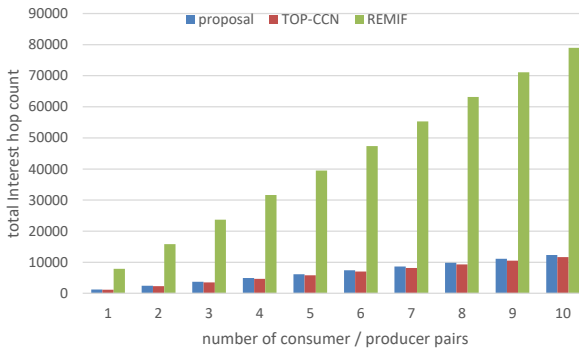

(b) $n=20$

Figure 7. Total Interest hop count (average).

node except the producer will rebroadcast each Interest once. So, the result is $100(4n - 1)m$.

(4) *Results*

Figure 7 shows the total Interest hop count (average) when n is 10 and 20, by changing the number of consumer / producer pairs (m) from 1 to 10. This figure indicates that the total number of REMIF is much larger than the others. The result of our proposal is slightly higher than TOP-CCN. By comparing Figures 7(a) and 7(b), the tendency is similar for two cases that n is 10 and 20. This is because the number of transmitted Interest packet changes in the order of n for three methods.

V. PERFORMANCE EVALUATION WITH MOVING NODE CONFIGURATION

In this section, we show the performance evaluation when one of the consumer side nodes moves around.

A. *Experiment configuration*

We use a network configuration as shown in Figure 8, which consists of thirty one nodes; thirty nodes are fixed, and

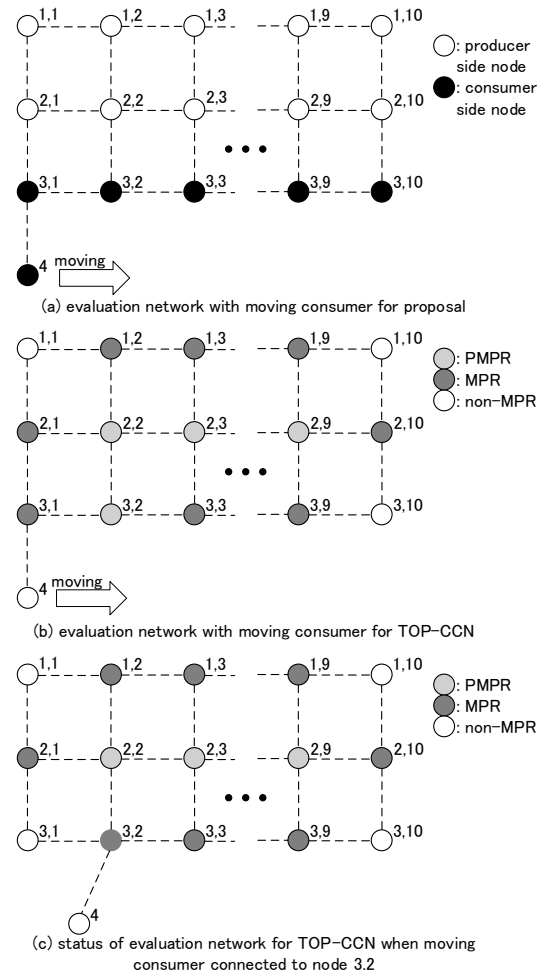

Figure 8. Evaluation network with moving consumer node for proposal and TOP-CCN.

one is moving from the left side end to the right side end. We assume that the distance between adjacent nodes is 10 meter and the speed of the moving node is 1 meter/sec. In this experiment, the moving node (node 4) is only the consumer that originates Interest packets, and the node located at the upper right position (node 1,1) is the producer.

In the case of our proposal, as shown in Figure 8(a), twenty nodes (1,1 through 2,10) work as producer side nodes, and eleven nodes (3,1 through 3,10 and 4) are consumer side nodes.

In TOP-CCN, the assignment of PMPR and MPR is given in Figures 8(b) and 8(c). When the moving node is communicating with the left end node in the third row (node 3,1), this node works as an MPR and its next node (node 3,2) is a PMPR (see Figure 8(b)). The situation is similar when node 4 communicates with node 3,10. In other cases, as shown in Figure (c), nodes 3,1 and 3,10 are non-MPRs, and the other nodes in the third row are MPRs.

In the case of REMIF, all nodes work in the same way, which is similar with the evaluation in the previous section.

We assume that node 4 sends Interest packet once per 100 msec, that is, the Interest sending rate is 10 packets/sec. In the cases of our proposal and TOP-CCN, we assume that the initial routing setting is done just before node 4 starts moving. We also assume the following route maintenance in our proposal and TOP-CCN. In our proposal, the route establish procedure, i.e. the exchange of the NPAREq and NPAREP packets are performed once per 10 seconds among the producer side nodes. In TOP-CCN, CA packets are sent periodically, once in one second by each node, to detect the change of network configuration, and if any route happens, CA packets are flooded that carry the changed neighborhood information.

B. Number of transmitted packets

Here, we analyze the time variation of the number of transmitted packets. The number of transmitted packets means the total hops of all packets used in the individual methods; control packets, Interest packets and Data packets.

(1) Our proposal

In the case of our proposal, the route setting is done at the beginning. The number of packets is obtained in the same as VI.B(1). The NPAREq packet originated by node 1,1 is rebroadcasted by the producer side nodes, once per node. One NPAREP packet is replied over each node. Therefore, the number of transmitted packets is $5 \times 10 - 2 = 48$. As described above, this name prefix advertisement procedure is repeated every 10 second.

On the other hand, when the consumer (node 4) sends the first Interest packet, it will be flooded throughout the consumer side node network. In this case, eleven nodes including the consumer itself are in the consumer side. Therefore, the first Interest packet is transmitted 11 times (rebroadcasted 10 times) in the consumer side. In the producer side network, it is forwarded once per a producer side node; 19 times in total. Therefore, in the case of the first Interest packet, it is transmitted 30 times. Since it establishes an FIB entry in the consumer side node, the following Interest

packets are sent through the shortest path to the producer 1,1. When node 4 is in the area of node 3,1, it is 3 hops.

When node 4 moves to the area of the next consumer side node, e.g., from node 3,1 to node 3,2, it is detected in a way such as the link level retry-out. Then, the consumer repeats the same procedure as the first Interest packet.

As for the Data packets from node 1,1 to node 4, we suppose that the shortest path is applied.

Figure 9 shows the time variation of the number of transmitted packets for our proposal. NPAREq and NPAREP packets are transmitted at every 10 second, the number is 48. At other timings, the number is zero. When sending the first Interest packet and when the consumer node changes the upstream node to the producer (every 10 second), the number of flooded or forwarded Interest packets becomes 30 or 31. At other timings, the number of transmitted Interest starts from 3 and goes up to 12 for each content request. The number of transmitted Data packet is 3 through 12 for each content request.

(2) TOP-CCN

In the case of TOP-CCN, the route setting is also performed at the beginning in the following way. As given in Figure 8(b), there are 9 PMPR nodes and 18 MPR nodes when the consumer is located in the left-most position. In this case, the number of CA packets required for the route setting is calculated similarly with IV.B(2). That is

$$2 \times 4 + 18 \times (4 + 9) + 9 \times (5 + 9) = 368.$$

After that, each node sends a CA packet once per one second for keeping the neighborhood relationship.

Next, when the consumer changes the upstream node to the producer from node 3,1 to node 3,2, the CA packets are exchanged in the following way. First, the consumer and the former MPA (node 3,1) broadcast a CA packet to report the change of network configuration. Then, node 3,2 reports the change to PMPR node 2,2 by a CA packet. Receiving this CA packet, node 2,2 generates a multi-hop CA packet which will be flooded among PMPR nodes. In the end, MPR nodes also report new routing information to their own MPR selectors. So, the total number of transmitted CA packets is

$$2 + 1 + 8 + 18 = 29.$$

When the consumer moves to the area of node 3,3, the situation is a little different. Since the route information of

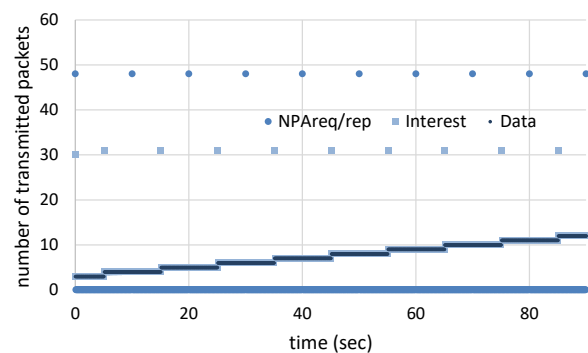

Figure 9. Time variation of transmitted packets for proposal.

PMPR nodes 2,2 and 2,3 changes, two multi-hop CA packets are flooded. The result is

$$1 + 2 + 2 \times 8 + 2 \times 18 = 55.$$

As for the Interest and Data packets, the shortest path (minimum hop transmission) is selected.

Figure 10 shows the time variation of the number of transmitted packets for TOP-CCN. In this case, the number of CA packets is either 368 (in the beginning), 29, 31, 55 or zero. The number of the Interest and Data packets is an optimal one.

(3) REMIF

In the case of REMIF, Interest packets are always flooded through all nodes except the producer. We suppose that Data packets are returned via the shortest path. Figure 11 shows the time variation of the number of transmitted packets for REMIF.

(4) Summary

Figure 12 shows the time variation of the total number of all kinds of packets transmitted. In the case of TOP-CCN, large number of CA packets need to be exchanged at the beginning as described above. After that, CA packets need to be exchanged occasionally, and otherwise the number of packets is relatively low. In the case of REMIF, the number of packets is relatively high throughout the experiment. In the proposed method, the number becomes high occasionally, but it is lower than TOP-CCN, and otherwise, the number is similar with TOP-CCN. Table II shows the total number of packets throughout one experimental run. This table shows

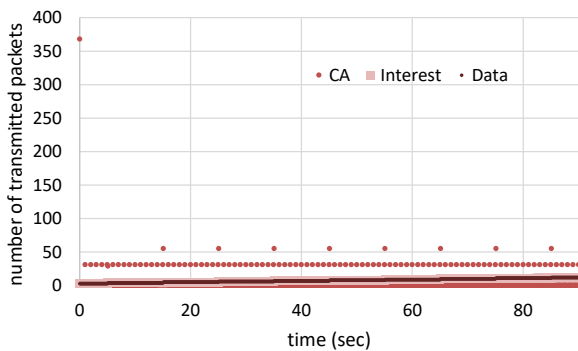

Figure 10. Time variation of transmitted packets for TOP-CCN.

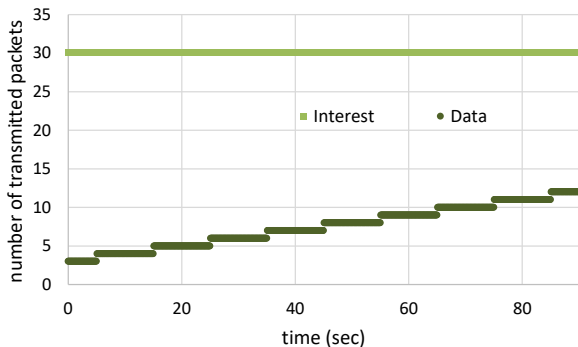

Figure 11. Time variation of transmitted packets for REMIF.

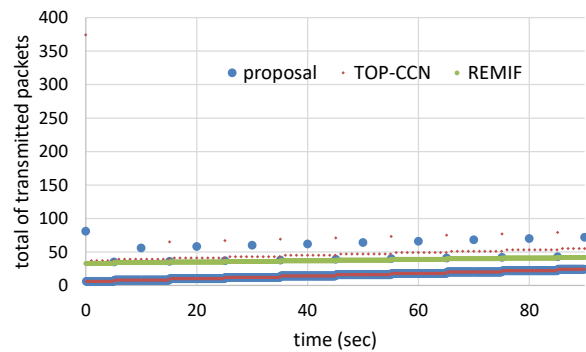

Figure 12. Time variation of total of transmitted packets.

TABLE II. TOTAL NUMBER OF TRANSMITTED PACKETS THROUGHOUT EXPERIMENT

| proposed | TOP-CCN | REMIF |
|----------|---------|--------|
| 14,220 | 17,133 | 33,783 |

that the number of packets in the proposed method is the smallest among the tree methods discussed here.

VI. CONCLUSIONS

In this paper, we proposed a new NDN based ad hoc routing protocol, which combines the proactive and reactive approaches. We assume that, in a common ad hoc network, nodes in the information provider side are located in a fixed position and user nodes are mobile terminals. The proposed method introduces a proactive routing in the producer side and a reactive routing in the consumer side. Our proactive routing focuses only on the name prefix advertisement. Through a theoretical analysis, we showed that our proposal provides a lighter routing overhead than TOP-CCN, a proactive approach, and the similar Interest transfer overhead with TOP-CCN, which is much better than REMIF, a reactive approach. We also conducted an analysis of the number of packets transferred in the network configuration where one consumer node moves. The results showed that the proposed method requires smaller packets, including Interest, data and control packets, than TOP-CCN and REMIF.

REFERENCES

- [1] N. Minh, R. Yamamoto, S. Ohzahata, and T. Kato, "A Routing Protocol Proposal for NDN Based Ad Hoc Networks Combining Proactive and Reavtive Routing Mechanisms," Proc. of AICT 2017, pp. 80-86, Jun. 2017.
- [2] V. Jacobson et al., "Networking Named Content," Proc. of CoNEXT '09, pp. 1-12, Dec. 2009.
- [3] D. Saxena, V. Raychoudhury, N. Suri, C. Becker, and J. Cao, "Named Data Networking: A survey," Computer Science Review, Vol. 19, pp. 15-55, Feb. 2016.
- [4] L. Wang, A. Hoque, C. Yi, A. Alyyan, and B. Zhang, "OSPFN: An OSPF Based Routing Protocol for Named Data Networking," NDN, Technical Report NDN-0003, pp. 1-15, Jul. 2012.
- [5] A. Hoque et al., "NLSR: Named-data Link State Routing Protocol," Proc. of ICN '13, pp. 1-6, Aug. 2013.

- [6] E. Hemmati and J. Garcia-Luna-Aceves, "A New Approach to Name-Based Link-State Routing for Information-Centric Networks," Proc. of ICN '15, pp. 29-38, Sep. 2015.
- [7] X. Liu, Z. Li, P. Yang, and Y. Dong, "Information-centric mobile ad hoc networks and content routing: A survey," Ad Hoc Network, Available online, pp. 1-14, Apr. 2016.
- [8] S. Yao, X. Zhang, F. Lao, and Z. Guo, "MobileCCN: Wireless Ad-hoc Content-centric Networks over SmartPhone," Proc. of ACM International Conference on Future Internet Tech. (CFI '13), pp. 1-2, Jun. 2013.
- [9] J. Kim, D. Shin, and Y. Ko, "TOP-CCN: Topology aware Content Centric Networking for Mobile Ad Hoc Networks," Proc. of ICON '13, pp. 1-6, Dec. 2013.
- [10] M. Amadeo, A. Molinaro, and G. Ruggieri, "E-CHANET: Routing, forwarding and transport in Information-Centric multihop wireless networks," Computer Communications, Vol.36, pp. 792-803, 2013.
- [11] R. Rehman, T. Hieu, and H. Bae, "Robust and Efficient Multipath Interest Forwarding for NDN-based MANETs," Proc. of WMNC '16, pp. 1-6, Jul. 2016.
- [12] G. Malkin, "RIP Version 2," IETF RFC 2453, Nov. 1998.
- [13] T. Clausen and P. Jacquet, "Optimized Link State Routing Protocol (OLSR)," IETF RFC 3626, Oct. 2003.
- [14] C. Perkins, E. Belding-Royer, and S. Das, "Ad hoc On-Demand Distance Vector (AODV) Routing," IETF RFC 3561, Jul. 2003.
- [15] F. Ducatelle, G. Caro, and L. Gambardella, "A New Approach for Integrating Proactive and Reactive Routing in MANETs," Proc. of MASS 2008, pp. 377-383, Sep. 2008.
- [16] J. Moy, "OSPF Version 2," IETF RFC 2328, Apr. 1998.
- [17] C. Yi et al., "A Case for Stateful Forwarding Plane," NDN, Technical Report NDN-0002, 2012.